

Composite dry sliding bushings, metric dimensions

Principal dimensions			Basic load ratings		Mass	Designation
d	D	B	dynamic C	static C0	kg	-
mm			kN			
80	85	60	375	1180	0,29	PCM 808560 E

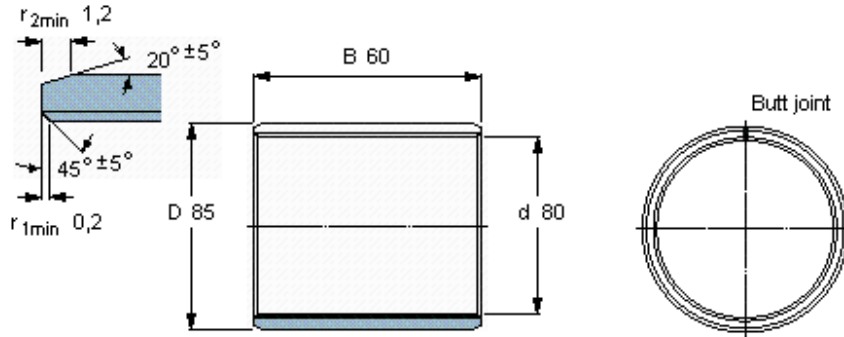

Specific load factor
Material constant

K 80
 K_M 480